

B1

STABILIZZATORE REGOLABILE
CON BLOCCO DI APPOGGIO
regolable stabilizator
with concrete pad

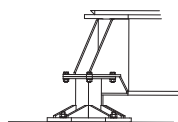

B2

STABILIZZATORE FISSO
fixed stabilizator

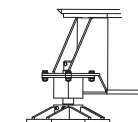

B2

STABILIZZATORE REGOLABILE
regolable stabilizator

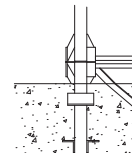

T4

TRONCHETTO DI FONDAZIONE
expendable foundation element



DATI ILLUSTRATIVI NON IMPEGNATIVI CON RISERVA DI MODIFICA SENZA PREAVVISO
Disegni e dati tecnici riportati nel presente depliant hanno lo scopo esclusivamente illustrativo e sono validi solo per uso commerciale. Per il corretto utilizzo della gru e per la consultazione di qualsiasi dato tecnico, si rimanda al manuale d'uso e manutenzione della macchina. L'inosservanza delle norme generali d'utilizzo riportate nel manuale e/o l'uso irresponsabile della gru possono arrecare gravi danni alla salute



SPECIFICATION AND DATA NOT BINDING SUBJECT TO MODIFICATION WITHOUT NOTICE
Drawings and technical data contained in this brochure are only illustrative and are valid only for commercial use. For the correct use of the crane and the consultation of any technical data, see the manual and machine maintenance. Failure to observe the general rules for use in the manual and/or irresponsible use of the crane can cause serious damage to health.



DIAGRAMMA DI PORTATA LOAD DIAGRAM LASTKURVEN COURBES DE CHARGES CURVAS DE CARGAS

m.	Portata max - Max s.w.l. - Charge maxi															2,0 t	
35	14	15	16	17	18	19	20	22	23	24	26	28,5	30	32	34	35	m.
	2,00	2,00	2,00	2,00	2,00	1,95	1,84	1,66	1,58	1,51	1,38	1,25	1,18	1,10	1,03	1,00	t
28,5	14	15	16	17	18	19	20	22	23	24	26	28,5	m.				
	2,00	2,00	2,00	2,00	2,00	2,00	1,98	1,79	1,70	1,62	1,49	1,35	t				
23	14	15	16	17	18	19	20	22	23	m.							
	2,00	2,00	2,00	2,00	2,00	2,00	2,00	1,82	1,74	t							
17	14	15	16	17	m.												
	2,00	2,00	2,00	2,00	t												

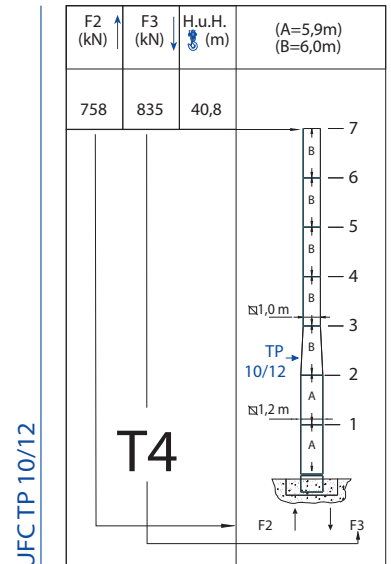
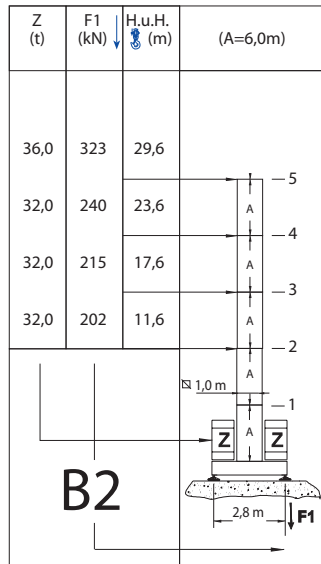
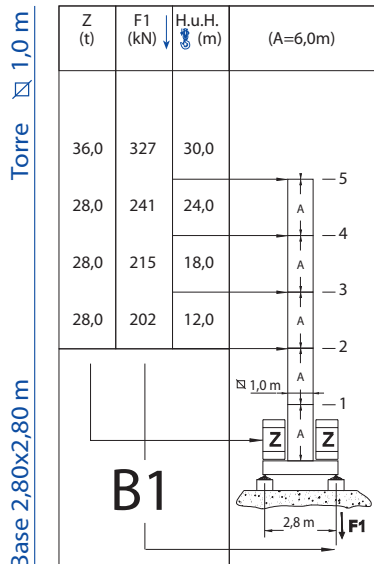
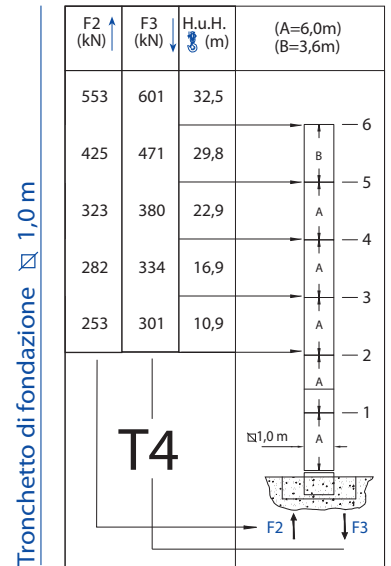
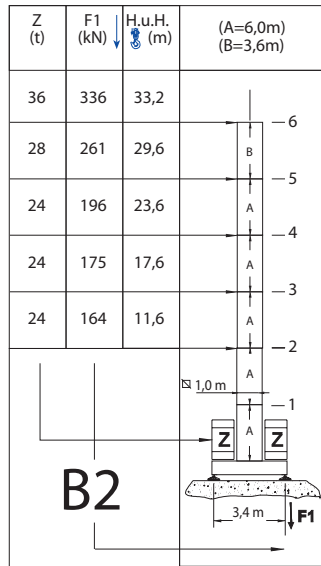
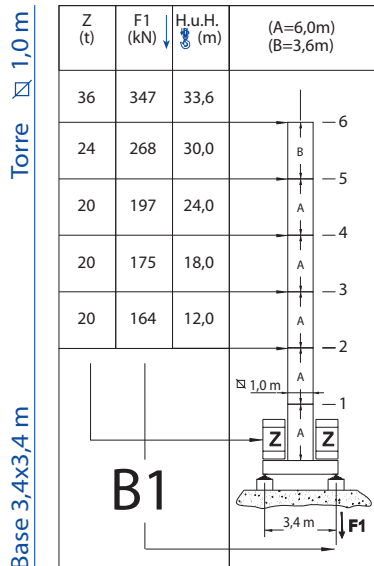
TORRE/REAZIONI TOWER/REACTIONS TURM/REAKTIONEN TOUR/REACTIONS MASTIL/REACCIONES



MECCANISMI MECHANISMS ANTRIEBE MÉCANISMES MECANISMOS

	giri/min	m/min	Nm	Kw
	1,02	-	35	-
	-	20/40	-	1,5
	-	-	-	1,8

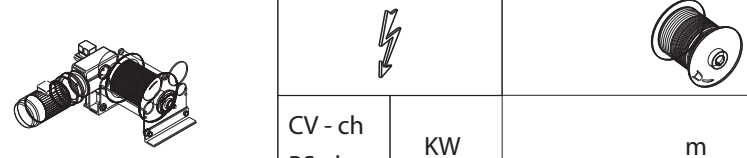
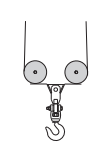



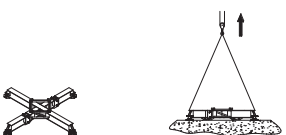
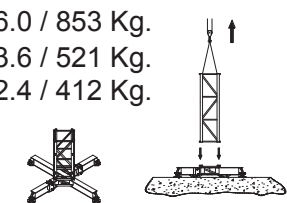
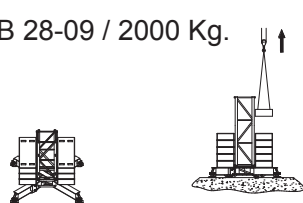
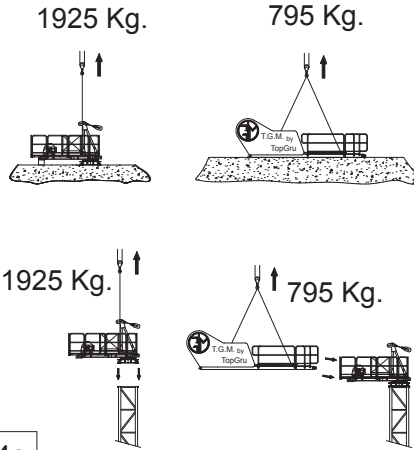
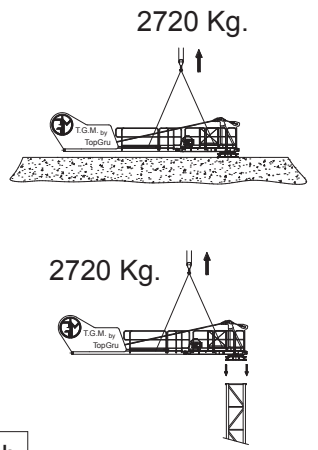
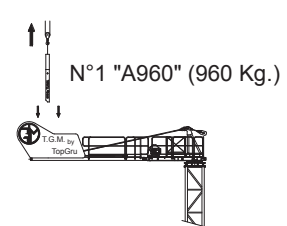
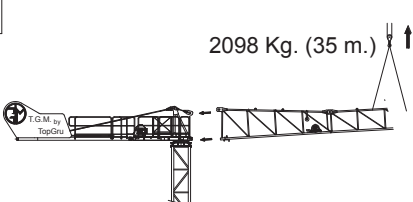

	⚡		m	marcia - step vitesse - gang velocidades		
	CV - ch PS - hp	KW			m/min	(t)
8 3S 20	12	8,8	90	1 2 3	5,5 22 44	2 2 1

Potenza totale richiesta Total installed power Geforderte Stromstärke Puissance totale nécessaire Potencia necesaria	8 3S 20 - 16kVA	400 V - 50 Hz
--	-----------------	---------------

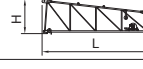
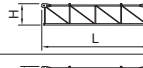



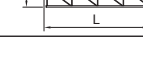
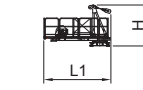
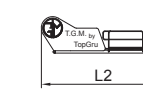
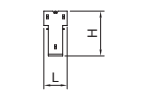
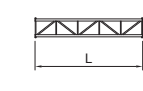
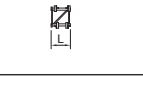

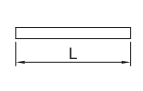
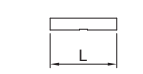







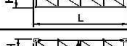

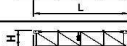



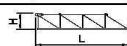



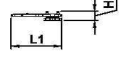



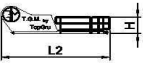



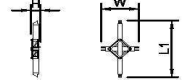

MONTAGGIO ASSEMBLY VERSAMMEWNG MONTAGE ASAMBLEA

1 B 3.4x3.4m Tot. 1604 Kg. B 2.8x2.8m Tot. 1427 Kg. 	2 6.0 / 853 Kg. 3.6 / 521 Kg. 2.4 / 412 Kg. 	3 B 28-09 / 2000 Kg. 
4a 1925 Kg. 795 Kg. 	4b 2720 Kg. 	5 N°1 "A960" (960 Kg.) 
		6 2098 Kg. (35 m.) 

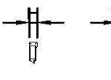
LISTA DEI PESI PACKING LIST KOLLI-LISTE LISTE DE COLLISAGE LISTA DE PESOS

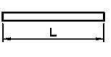
Pos. Item	Pezzi Pieces	Denominazione Description	Schizzo Sketch	Dimensioni Dimensions			Peso Weight (Kg)		
				L	W	H	Unit.	Total.	
1	1	Elemento di freccia Jib element Ausleger Elément de flèche Elemento de flecha	N°1 	5.930	0.790	1.930	615	615	
	1		N°2 	5.985	0.790	1.190	364	364	
	1		N°3 	5.985	0.790	1.190	321	321	
	1		N°4 	5.985	0.790	1.190	297	297	
	1		N°5 	5.985	0.790	1.190	263	263	
	1		N°6 	5.860	0.790	1.190	238	238	
2	1	Gruppo Controfreccia girevole Group Counterjib-turntable Groupe Gegenausleger Groupe Contreflèche tournante Contraflecha giratorio		3.75	1.705	2.3	1925	1925	
3	1	Elemento controfreccia esterno External counterjib. Externes Gegenausleger. Contreflèche extérieure. Elemento de contraflecha externo		6.9	0.875	1.23	795	795	
4	5	Blocchi di contrappeso Counterweight block Gegengewichtsblöcke Contre-poids Bloques de contrapeso		A 960	1.30	0.185	960	4800	
5	1	Elemento di torre Tower element Turmstück Elément de mature Elemento de torre		6.0 3.6 2.4	1.11 1.11 1.11	1.11 1.11 1.11	853 521 412	853 521 412	
6	1	Tronchetto di fondazione Expendable foundation element Fundamentanker Elément a sceller Tronco de fundación		1,075	1,11	1,11	309	309	
7	1	Trave principale di base Base main beam Hauptträger für Kreuzgelenk Poutre de chassis de base Viga principal de la base		(2,8x2,8m) 5.01	2.4 2.4	0.605 0.605	1083 1154	1083 1154	
	2	Semi-trave di base Half bass beam Hauptträger für Kreuzgelenk Semipoutre de chassis de base Mediaviga de la base		(2,8x2,8m) 1.575	0.3 0.3	0.49 0.49	172 225	344 450	
8	18	Blocco di zavorra Base ballast block Grundballastblöcken Lest de base Bloque de lastre		(2,8x2,8m)	2.800	0.900	0.360	2000	36000
	18			(3,4x3,4m)	2.800	0.900	0.360	2000	36000
9	4	Blocco di appoggio Concrete pad Betonfuss Sabot en béton Bloque de apoyo		2.400	0.450	0.450	1000	4000	

LISTA DEI PESI PACKING LIST KOLL-LISTE LISTE DE COLLISAGE LISTA DE PESOS

Pos. Item	Pezzi Pieces	Denominazione Description	Schizzo Sketch	Dimensioni Dimensions			Peso Weight (Kg)			
				L	W	H	Unit.	Total.		
1	1	Elemento di freccia Jib element Ausleger Elément de flèche Elemento de flecha	N°0 		5.985	0.790	2.040	683	683	
	1		N°1 		5.985	0.790	1.930	410	410	
	1		N°2 		5.985	0.790	1.190	364	364	
	1		N°3 		5.985	0.790	1.190	321	321	
	1		N°4 		5.985	0.790	1.190	297	297	
	1		N°5 		5.985	0.790	1.190	263	263	
	1		N°6 		5.860	0.790	1.190	238	238	
2	1	Gruppo Controfreccia girevole Group Counterjib-tumbletable Gruppe Gegenausleger Groupe Contreflèche tournante Contreflecha giratorio			3.25	1.10	0.8	1020	1020	
	1	Cuspide A frame Pointe Turmspitze Contreflecha removable			1.25	0.75	1.8	300	300	
3	1	Elemento controfreccia esterno External counterjib Externes gegenausleger Contreflèche extérieure Elemento de controflecha externo			6.9	0.875	1.23	795	795	
4	8	Blocchi di contrappeso Counterweight block Gegengewichtsbloecke Contre-poids Bloques de contrapeso			A 960	1.30	0.185	2.50	960	7680
5	1	Elemento di torre Tower element Turmstück Elément de mature Elemento de torre			5.9	1.11	1.11	985	985	
					3.6	1.11	1.11	600	600	
					2.4	1.11	1.11	460	460	
6	1	Tronchetto di fondazione Expendable foundation element Fundamentanker Elément a sceller Tronco de fundacion			1,075	1,11	1,11	334	334	
7	1	Trave principale di base Base main beam Hauptträger for kreuzgelenk Poutre de chassis de base Viga principal de la base			TP (2,8x2,8m) TP (3,4x3,4m)	4.16 5.01	2.4 2.4	0.605 0.605	1083 1154	1070 1154
	2	Semi-trave di base Half base beam Hauptträger for kreuzgelenk Semipoutre de chassis de base Mediaviga de la base			TP (2,8x2,8m) TP (3,4x3,4m)	1.15 1.575	0.3 0.3	0.49 0.49	172 225	344 450
8	24	Blocco di zavorra Base ballast block Grundballastblöcken Lest de base Brique de lastre			(2,8x2,8m)	2.800	0.900	0.360	2000	48000
	48					2.800	0.900	0.180	1000	48000
	22					2.800	0.900	0.360	2000	44000
44	2.800	0.900	0.180	1000	44000					
9	4	Blocco di appoggio Concrete pad Betonfuss Sabot en béton Bloque de apoyo			(BA 2)	2.400	0.450	0.450	1000	4000